

Series 602, 604, 624 Product Overview

Features:

- Versatile and compact straight line action clamps
- Threaded body for through hole mounting
- **-SS** models are stainless steel

Applications:

- Assembly
- Checking fixtures
- Welding fixtures
- Tensioning devices

Also Available:

See page 7.1 for accessories

602
602-**SS**
602-**MM**
602-**MMSS**



604
604-**SS**
604-**MM**
604-**MMSS** ⓘ



624
624-**SS**
624-**MM**



Series 602, 604, 624 Technical Information, Holding Capacities, Standard Clamp Dimensions

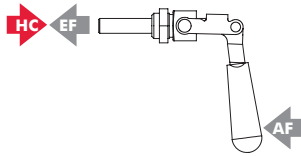

Model	Max. Holding Capacity	Weight	EF:AF (pushing/pulling)	Plunger Travel (M)	Plunger Thread	Spindle (Recommended)	Mounting Nut (Supplied)
602	[200 lbf] 900 N	[0.12lb] 0,05kg	31:1/28:1	[0.75] 19	1/4-20	205203	602105
602-SS					202943	602905	
602-MM					M6	205203-M	602105-M
602-MMSS					202943-M	602905-M	
604	[300 lbf] 1330 N	[0.44lb] 0,20kg	45:1/26:1	[1.50] 38	5/16-18	207203	606104
604-SS	[400 lbf] 1780 N					--	606904
604-MM	[300 lbf] 1330 N				M8	207943	606104-M
604-MMSS ⓘ	[400 lbf] 1780 N				207943-M (included)	606904-M	
624	[700 lbf] 3110 N	[1.63lb] 0,74kg	49:1/21:1	[2.63] 66	3/8-16	210203	624105
624-SS						237943 (included)	624905
624-MM					M10	210203-M	624105-M

ⓘ This item is available upon request **HC** = Holding Capacity, **EF** = Exerting Force, **AF** = Applied Force

Series 602, 604, 624 Standard Clamp Dimensions 602/604/624/-SS/-MM/-MMSS

602
602-SS
602-MM
602-MMSS



604
604-SS
604-MM
604-MMSS ⓘ



624
624-SS
624-MM

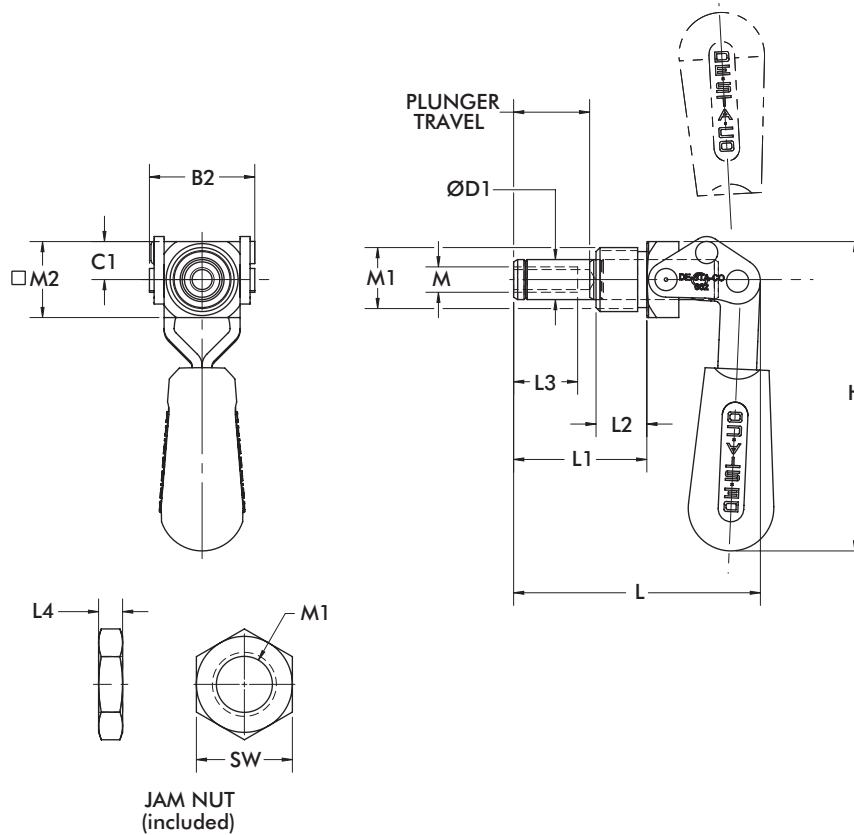

Model no.	B2	C1	ØD1	H	L	L1	L2	L3	L4	M1	M2	SW
602			[0.39] 10									
602-SS	[1.04]	[0.37]	[0.37] 9,5	[3.13]	[2.43]	[1.31]	[0.50]	[0.63]	[0.25]	5/8-18	[0.75]	[0.88]
602-MM	26,3	9,5		80	61,7	33,3	12,7	16	6,4	M16x1.5	19	[0.87]
602-MMSS			[0.39] 10									22
604												
604-SS	[1.30]	[0.44]	[0.44]	[4.16]	[4.27]	[2.18]	[1.82]	[1.00]		3/4-16	[0.88]	[1.00]
604-MM	33	11	11	106	108,5	55	46	25		M20x1.5	22	[1.18]
604-MMSS									[0.25] 6			30
624												
624-SS	[1.81]	[0.75]	[0.62]	[5.60]	[6.68]	[3.62]	[3.24]	[1.25]		1-14	[1.25]	[1.50]
624-MM	46	19	16	142	170	92	82	32		M27x2	32	[1.61]
												41

Dimensions shown mm [inch]

Mounting Plates for Series 602, 604, 624, 6004 Product Overview

Features:

- Mounting accessories for Threaded Body Straight Line Action Clamps

602106-M

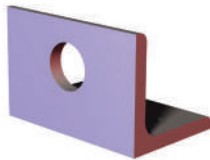

604106,
604106-M



624106-M

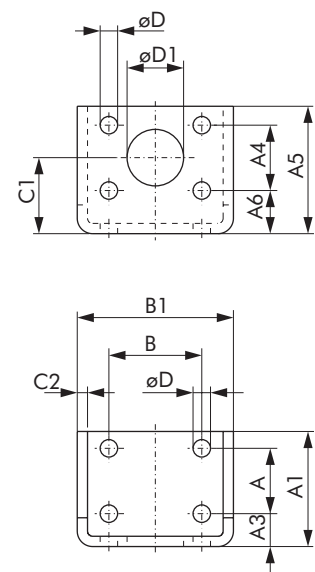
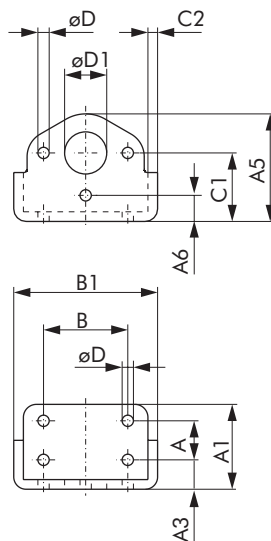
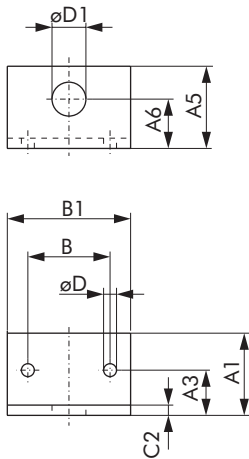
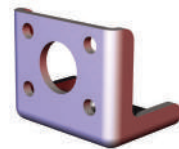

Item Number	For Use With	A	A1	A3	A4	A5	A6	B	B1	C1	C2	D	D1
602106-M	602 602-MM	--	[1.57] 40	[0.87] 22	--	[1.57] 40	[0.94] 24	[1.57] 40	[2.36] 60	--	[0.20] 5	[0.25] 6,3	[0.65] 16,5
604106	604 6004	[0.75] 19,1	[1.60] 40,6	[0.55] 14	--	[2.05] 52,1	[0.50] 12,7	[1.62] 41,1	[2.80] 71,1	[1.30] 33	[0.19] 4,7	[0.22] 5,6	[0.75] 19,1
604106-M	604-MM 6004-MM												[0.81] 20,5
624106-M	624 624-MM	[1.25] 31,8	[2.20] 56	[0.63] 16	[1.25] 31,8	[2.44] 62	[0.83] 21	[1.78] 45,2	[2.99] 76	[1.46] 37	[0.20] 5	[0.33] 8,5	[1.08] 27,5

Dimensions shown mm [inch]